

Pneumatically operated 2/2 way angle seat valve ELEMENT for decentralized automation



- High flow rate
- Long service life
- Easy integration of automation units with ELEMENT
- Flow-optimized stainless steel housing with threaded, clamp or weld connection
- Suitable for 10 bar(g) steam

Type 2100 clamp can be combined with...



Type 8691

Control Head



Type 8695

Control Head



Type 8690

Pneumatic Control Unit



Type 8697

Pneumatic Control Unit

For process valves with centralized automation see CLASSIC Type 20xx



The angle seat valve, Type 2100, is specially optimized for decentralized process automation and fulfils tough criteria for process environments. The design enables the easy integration of automation units whether they are electrical/optical position feedback, pneumatic control units or an integrated fieldbus interface. Unrivalled cycle life and sealing integrity is guaranteed by the proven self adjusting spindle packing with V-seals.

The fully integrated system has a compact and smooth design, integrated pneumatic lines, IP65/67, NEMA Type 4X protection class and superior chemical resistance.

Technical data	
Orifice	DN15 to DN50
Port connections	Clamp acc. to ISO 2852, ASME BPE Weld and threaded see separate data sheet
Body material	Stainless steel 316L
Nominal pressure	PN25 (Body)
Actuator material	Actuator: PPS Cover: Stainless steel 1.4561 (316Ti)
Sealing material	PTFE
Medium	Water, alcohol, oils, fuels, hydraulic fluids, salt solution, alkali solutions, organic solvents, steam, optional fuel gas (EC Gas Appliances Directive 2009/142/EG)
Viscosity	max. 600 mm ² /s
Spindle packing	PTFE V-rings with spring compensation
Medium temperature	- 10 to + 185 °C
Ambient temperature	- 10 to + 60 °C (push-in air ports) - 10 to + 100 °C (threaded air ports)
Control medium	Neutral gases, air
Max. pilot pressure	max. 10 bar; actuator size 130 mm, 7 bar
Pilot air ports	Push-in connector for external Ø 6 mm or ¼" tube, thread G ½ (on request)
Installation	As required, preferably with actuator in upright position
Surface Finish, standard	in internal connection area ¹⁾ Ra ≤ 0.6 µm electropolished (external cast surface)

¹⁾ In the seat area the Ra ≤ 0.6 µm surface finish can be higher.

Content

Valve specifications		System spec. On/Off ELEMENT		Request for quotation
 Type 2100		 Type 8801-YE		Type 8801-YE
Technical data & ordering info.	p. 1 - 6	Technical data & ordering info.	p. 7 - 11	p.12









**2100 clamp
System On/Off
ELEMENT 8801-YE**

Ordering information for decentralized automation of On/Off ELEMENT valve system Type 8801-YE

A decentralized, automated **On/Off ELEMENT valve system Type 8801-YE** consists of a **angle seat valve Type 2100** and a valve control head **Type 8691/8695** or a pneumatic control unit **Type 8690/8697** (see separate datasheets).

For the configuration of further valve systems please use the "Request for quotation" on page 13-14

You order two components and receive a complete assembled and certified valve.

Angle seat valve Type 2100 Clamp	Control Head		Pneumatic Control Unit / Feedback	
	Type 8691	Type 8695	Type 8690	Type 8697
	 More info.	 More info.	 More info.	 More info.
Valve System On/Off ELEMENT				
				
	Valve System Type 8801-YE-H 2100+8691 (Actuator size Ø 70/90/130 mm)	Valve System Type 8801-YE-M 2100+8695 (Actuator size Ø 50 mm)	Valve System Type 8801-YE-K 2100+8690 (Actuator size Ø 70/90/130 mm)	Valve System Type 8801-YE-U 2100+8697 (Actuator size Ø 50 mm)

A detailed description of the control heads and pneumatic control units is on the next page... →

2100 clamp
System On/Off
ELEMENT 8801-YE

Ordering information for decentralized automation of On/Off ELEMENT valve system Type 8801-YE

Control Head



More info.



More info.

Type 8691

Actuator size Ø 70/90/130 mm

Type 8695

Actuator size Ø 50 mm

The Control Head Type 8691/ 8695 is optimised for integrated mounting on the 21XX process valve series. The registration of the valve end position is done through a contactless analog position sensor, which automatically recognises and saves the valve end position through the Teach function when starting up. The integrated pilot valve controls single or double-acting actuators. The status of the valve is shown through high power coloured LEDs.

Features

- High power coloured Status-LEDs
- Contactless inductive position sensor
- Pilot valve with manual override
- Teach function for automatic registration of valve positions
- Hygienic stainless steel design
- Easy to clean chemically resistant housing featuring IP65 / IP67, 4X Rating
- AS-Interface or DeviceNet Fieldbus communication

Benefits

- Easy and safe Start-up through Teach function
- Easy process monitoring and error detection through clearly visible high-power coloured LEDs
- High plant availability due to prolonged actuator life boosted by spring chamber ventilation
- Minimised space requirement in the plant piping for more flexibility in plant design

Pneumatic Control Unit / Feedback



More info.



More info.

Type 8690

Actuator size Ø 70/90/130 mm

Type 8697

Actuator size Ø 50 mm

The pneumatic control unit Type 8697/8690 is optimised for integrated mounting on the 21XX process valve series. Mechanical or inductive limit switches register the position of the valve. The integrated pilot valve controls single or double-acting (8690) actuators.

Features

- Visual position indicator
- Mechanical or inductive limit switches for end position registering
- Pilot valve with manual override
- Compact design
- Easy to clean chemically resistant housing featuring IP65 / IP67, 4X Rating
- Optional intrinsically safe version acc. to ATEX

Benefits

- Easy and safe Start-up through Teach function (Type 8697)
- High level of signal reliability thanks to self adjusting limit switches
- Minimised space requirement in the plant piping for more flexibility in plant design

Click on the orange box "More info"... you will come to our website for the resp. product where you can download the data sheet.

Technical data angle seat valve Type 2100 flow direction below the seat (for gases and liquids)

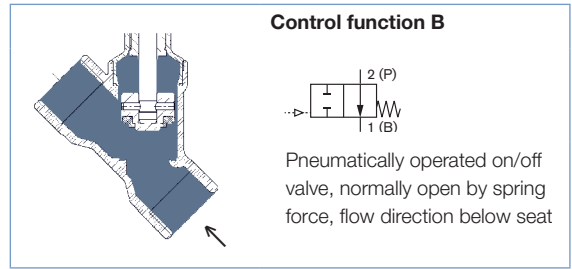
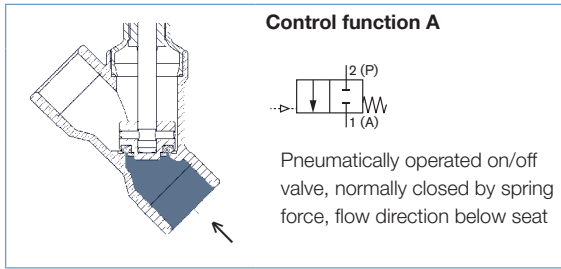

Orifice [mm]	Actuator size [mm]	K _v value water (m ³ /h)	Minimum pilot pressure CFA [bar]	Operating pressure up to +185 °C	
				CFA [bar]	CFB [bar]
15	50	5	5.2	25	16
	70	5	5.0	25	16
20	50	10	5.2	16	16
	70	11	5.0	20	16
25	50	15	5.2	9	14.5
	70	18	5.0	16	16
32	70	27	5.0	8.5	16
	90	28	5.0	16	16
	130	28	5.0	16	16
40	70	38	5.0	6	16
	90	40	5.0	16	16
50	70	52	-	-	16
	90	55	5.0	10	16
	130	62	5.0	16	16





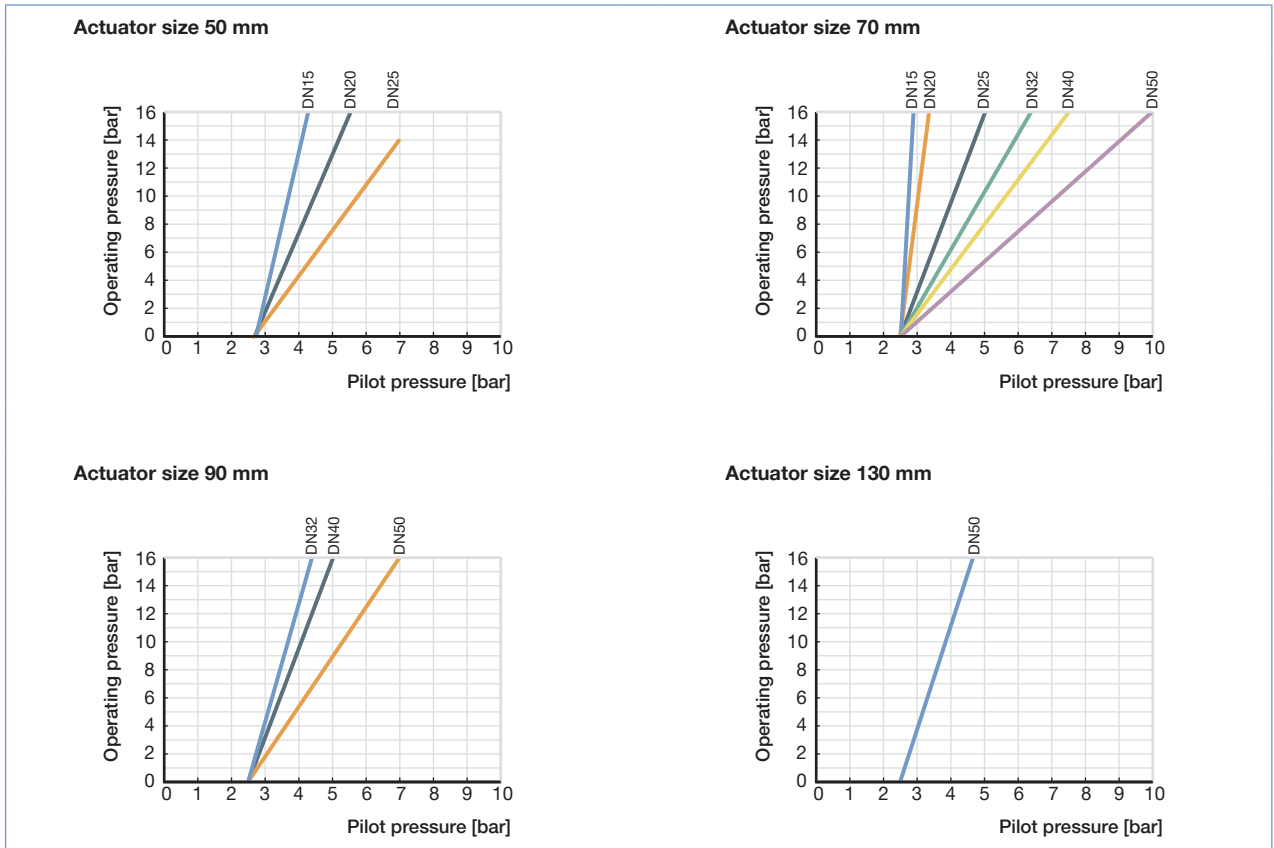





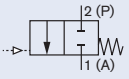







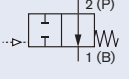

Flow rate: K_v value water [m³/h]: Measured at +20 °C, 1 bar pressure at valve inlet and free outlet.
Pressure valves [bar]: Overpressure to the atmospheric pressure

Pressure charts with control function B and flow direction below the seat











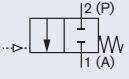







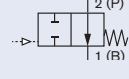

Ordering chart Type 2100, flow direction below the seat (for gases and liquids)

Clamp acc. to ISO 2852, flow direction below the seat

Control function	Orifice (mm)	Actuator size Ø [mm]	Port connection clamp external Ø (mm)	Minimum pilot pressure [bar]	Operating pressure up to +185 °C [bar]	Article no.	
A 2/2 way valve, NC 	15	50	34.0	5.2	25	187097 	
		70	34.0	5.0	25	188783 	
	20	50	50.5	5.2	16	209437 	
		70	50.5	5.0	20	188784 	
	25	50	50.0	5.2	9	227613 	
		70	50.5	5.0	16	188785 	
	32	70	50.5	5.0	8.5	188786 	
		90	50.5	5.0	16	188787 	
	40	70	64.0	5.0	6	188788 	
		90	64.0	5.0	16	188789 	
	50	90	77.5	5.0	10	188790 	
		130	77.5	5.0	16	188791 	
	B 2/2 way valve, NO 	15	50	34.0	see chart on p. 2	16	187101 
			70	34.0		16	188800 
20		50	50.5	16		187102 	
		70	50.5	16		188801 	
25		70	50.5	16		188802 	
32		70	50.5	16		188803 	
40		70	64.0	16		188804 	
50		70	77.5	16		188805 	

Clamp acc. to ASME BPE, flow direction below the seat

Control function	Orifice (mm)	Actuator size Ø [mm]	Port connection clamp external Ø (mm)	Minimum pilot pressure [bar]	Operating pressure up to +185 °C [bar]	Article no.	
A 2/2 way valve, NC 	15	50	25.0	5.2	25	187103 	
		70	25.0	5.0	25	188806 	
	20	50	25.5	5.2	16	227614 	
		70	25.5	5.0	20	188807 	
	25	50	50.5	5.2	9	227615 	
		70	50.5	5.0	16	188808 	
	40	70	50.5	5.0	6	188809 	
		90	50.5	5.0	16	188810 	
	50	90	64.0	5.0	10	188811 	
		130	64.0	5.0	16	188812 	
	B 2/2 way valve, NO 	15	50	25.0	see chart on p. 2	16	187107 
			70	25.0		16	188820 
		20	50	25.0		16	187108 
			70	50.5		16	188821 
25		70	50.5	16		188822 	
40		70	50.5	16		188823 	
50		70	64.0	16		188824 	

 Further versions on request

 Control function
I (double-acting)

Technical data angle seat valve Type 2100 flow direction above the seat (for gases and steam)

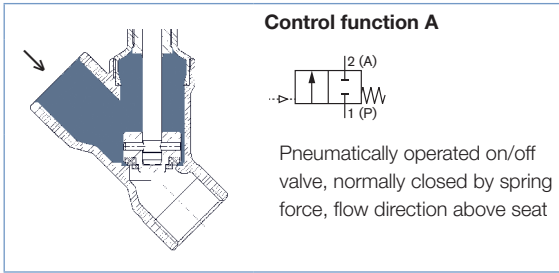

Attention!

Valves with flow above the seat are only conditionally usable for liquid medium. There is a danger of waterhammer!

Orifice [mm]	Actuator size [mm]	K_v value water (m ³ /h)	Operating pressure up to +185 °C CFA [bar]
15	50	5	16
	70	5.1	16
20	50	10	16
	70	12	16
25	50	15	16
	70	19	16
32	70	28	16
40	70	38	16
	90	40	16
50	70	50	12
	90	55	16

Flow rate: K_v value water [m³/h]: Measured at +20 °C, 1 bar pressure at valve inlet and free outlet.
Pressure valves [bar]: Overpressure to the atmospheric pressure

Pressure charts with control function A and flow direction above the seat

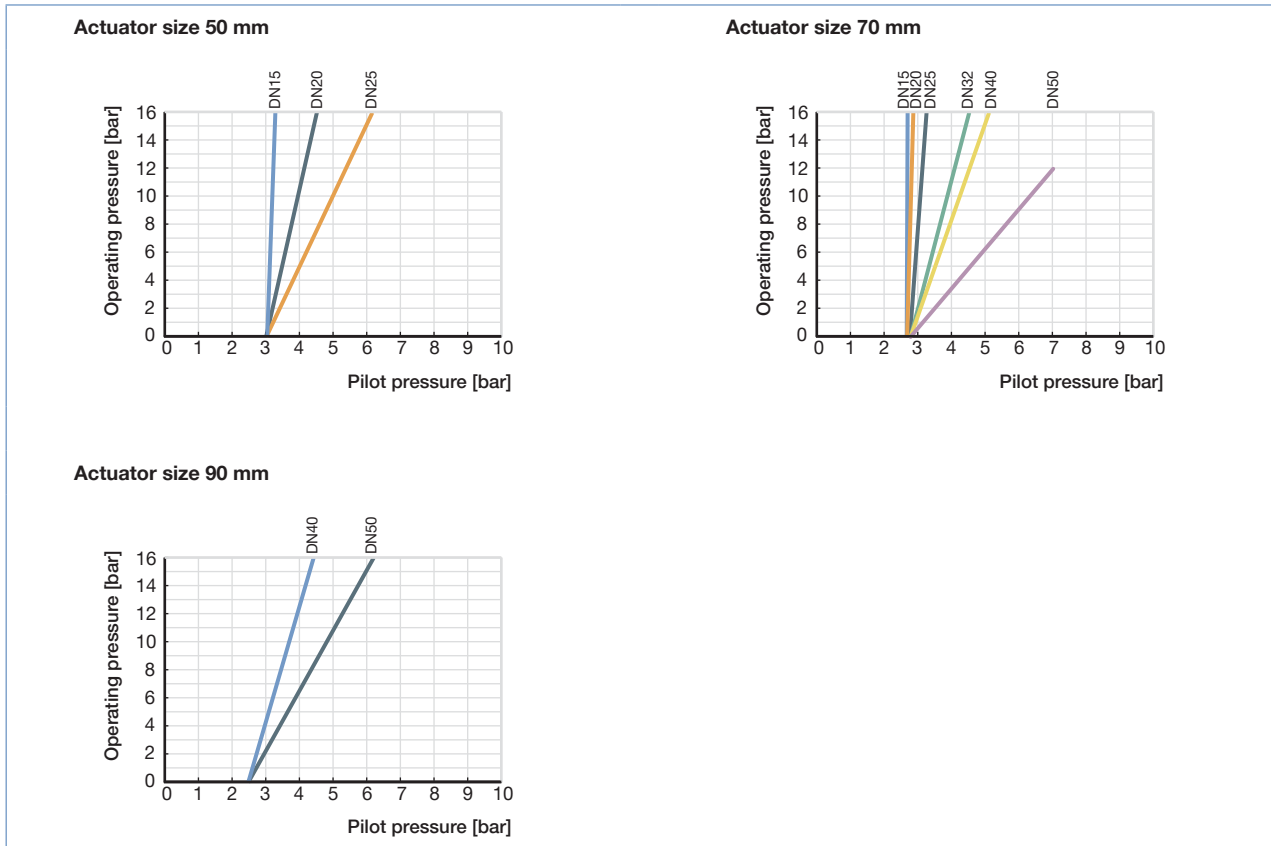

Ordering chart Type 2100 flow direction above the seat (for gases and steam)

Clamp acc. to ISO 2852, flow direction above the seat

Control function	Orifice (mm)	Actuator size Ø [mm]	Port connection clamp external Ø (mm)	Minimum pilot pressure [bar]	Operating pressure up to +185 °C [bar]	Article no.
A 2/2 way valve. NC 	15	50	34.0	see chart on p. 4	16	187098
	20	50	50.5		16	187099
	25	50	50.5		16	187100
	32	70	50.5		16	188795
	40	70	64.0		16	188796
	50	70	77.5		12	188798

Clamp acc. to ASME BPE, flow direction above the seat

Control function	Orifice (mm)	Actuator size Ø [mm]	Port connection clamp external Ø (mm)	Minimum pilot pressure [bar]	Operating pressure up to +185 °C [bar]	Article no.
A 2/2 way valve. NC 	15	50	25.0	see chart on p. 4	16	187104
	20	50	25.0		16	187105
	25	50	50.5		16	187106
	40	70	50.5		16	188816
	50	70	64.0		12	188818

Materials angle seat valve Type 2100

A	Ground terminal	Stainless steel 1.4301/1.4305 <i>Only for the ATEX version</i>
1	Optical position indicator	Transparent cap polysulfone PSU
2	Pilot air ports	Push-in connector PP (standard) <i>On request:</i> Thread G 1/8" stainless steel 1.4305
3	Actuator	PPS
4	Cover	Stainless steel 1.4561 (316Ti)
5	Piston seal	FKM
6	Spring	Stainless steel 1.4310
7	Pipe	Stainless steel 1.4401 (316)/1.4404 (316L)
8	Spindle packing	PTFE
9	Spindle	Stainless steel 1.4401 (316)/1.4404 (316L)
10	Spindle guide	PEEK
11	Swivel plate	Stainless steel 1.4401 (316)/1.4404 (316L)
12	Seals	PTFE
13	Valve body	Stainless steel 316L

Lubricants for spindle packing and actuator are classified according NSF H1

Dimensions angle seat valve Type 2100 [mm]

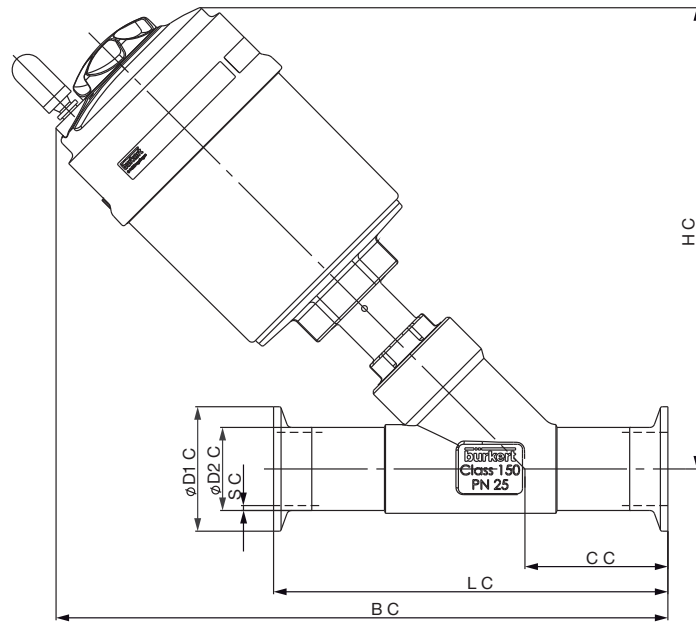

All bodies				DIN 32676 Serie B					DIN 32676 Serie A				
DN	Actuator size [mm]	HC	BC	CC	LC	ø D1C	ø D2C	SC	CC	LC	ø D1C	ø D2C	SC
15	D (50)	160	211	49*	130*	34*	21,3*	1,6*	49.5	130	34	19	1.5
	M (70)	175	227										
20	D (50)	167	226	56.5	150	50.5	26.9	1.6	57	150	34	23	1.5
	M (70)	182	242										
25	D (50)	172	232	58	160	50.5	33.7	2	58.5	160	50.5	29	1.5
	M (70)	188	248										
32	M (70)	195	261	57,5*	180*	50,5*	42,4*	2*	58	180	50.5	35	1.5
	N (90)	240	303										
40	M (70)	201	273	69	200	64	48.3	2	69.5	200	50.5	41	1.5
	N (90)	245	316										
	P (130)	296	365										
50	M (70)	219	300	77.5	230	77.5	60.3	2.6	78	230	64	53	1.5
	N (90)	260	339										
	P (130)	311	389										

* Similar to DIN 32676 (old ISO 2852)

All bodies				BS 4825-3					ASME BPE				
DN	Actuator size [mm]	HC	BC	CC	LC	ø D1C	ø D2C	SC	CC	LC	ø D1C	ø D2C	SC
15	D (50)	163	215	49	130	25.2	12.7	1.2	49	130	25	12.7	1.65
	M (70)	178	231										
20	D (50)	171	230	56.5	150	25.2	19.05	1.2	56.5	150	25	19.05	1.65
	M (70)	186	246										
25	D (50)	172	233	58	160	50.5	25.4	1.65	58	160	50.5	25.4	1.65
	M (70)	188	249										
32	M (70)	197	258										
	N (90)	242	300										
40	M (70)	201	273	69	200	50.5	38.1	1.65	69	200	50.5	38.1	1.65
	N (90)	245	316										
	P (130)	296	365										
50	M (70)	219	300	77.5	230	64	50.8	1.65	77.5	230	64	50.8	1.65
	N (90)	261	340										
	P (130)	312	389										

Dimensions for valve system On/Off ELEMENT Type 8801-YE [mm]

Dimensions valve system On/Off ELEMENT Type 8801-YE-K (with pneumatic control unit Type 8690)

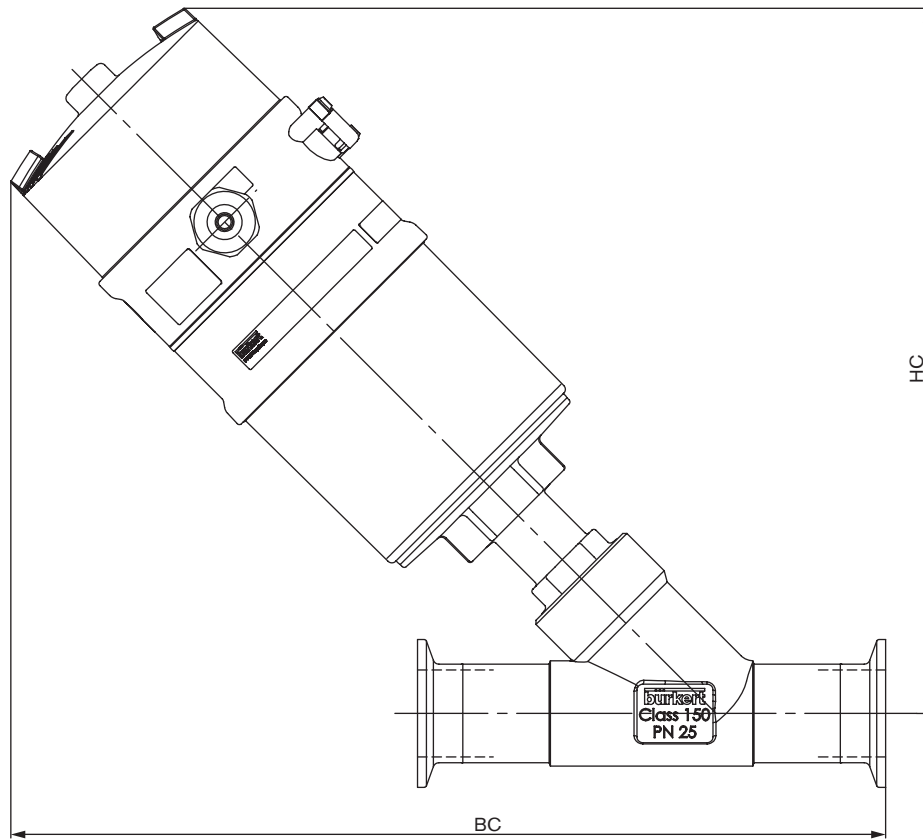

Clamp body acc. to ISO 2852, DIN 32676, BS 4825, ASME BPE

Orifice [mm]	Actuator size [mm]	HC	BC
15	70	232	285
20	70	240	300
25	70	242	303
32	70	251	312
	90	294	352
40	70	255	327
	90	297	368
	130	334	403
50	70	273	354
	90	313	392
	130	350	427

Further dimensions see p. 6

Dimensions for valve system On/Off ELEMENT Type 8801-YE [mm]

Dimensions valve system On/Off ELEMENT Type 8801-YE-K (with pneumatic control unit Type 8697)

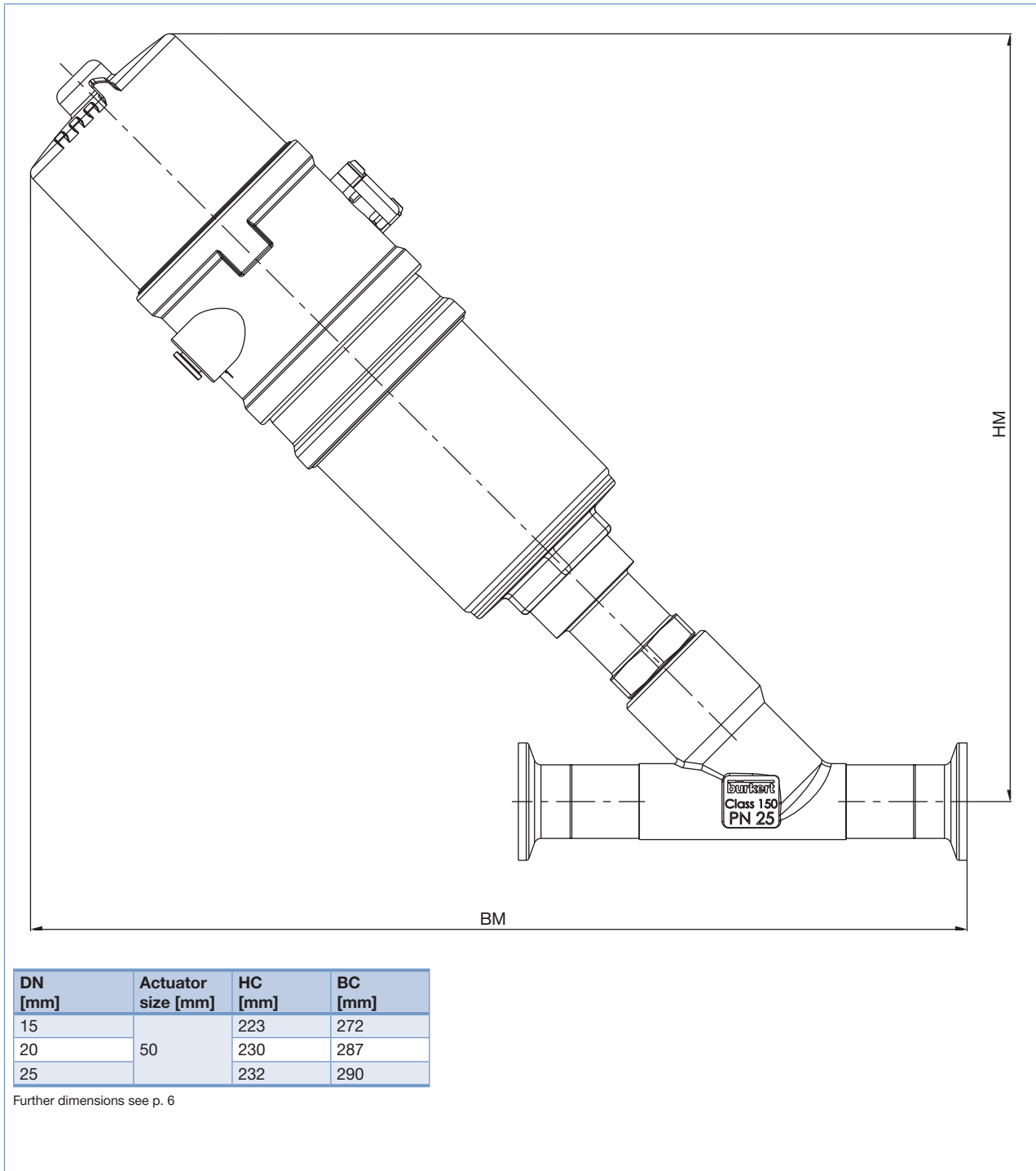

Dimensions for valve system On/Off ELEMENT Type 8801-YE [mm], *continued*

Dimensions valve system On/Off ELEMENT Type 8801-YE-H (with pneumatic control unit Type 8691)

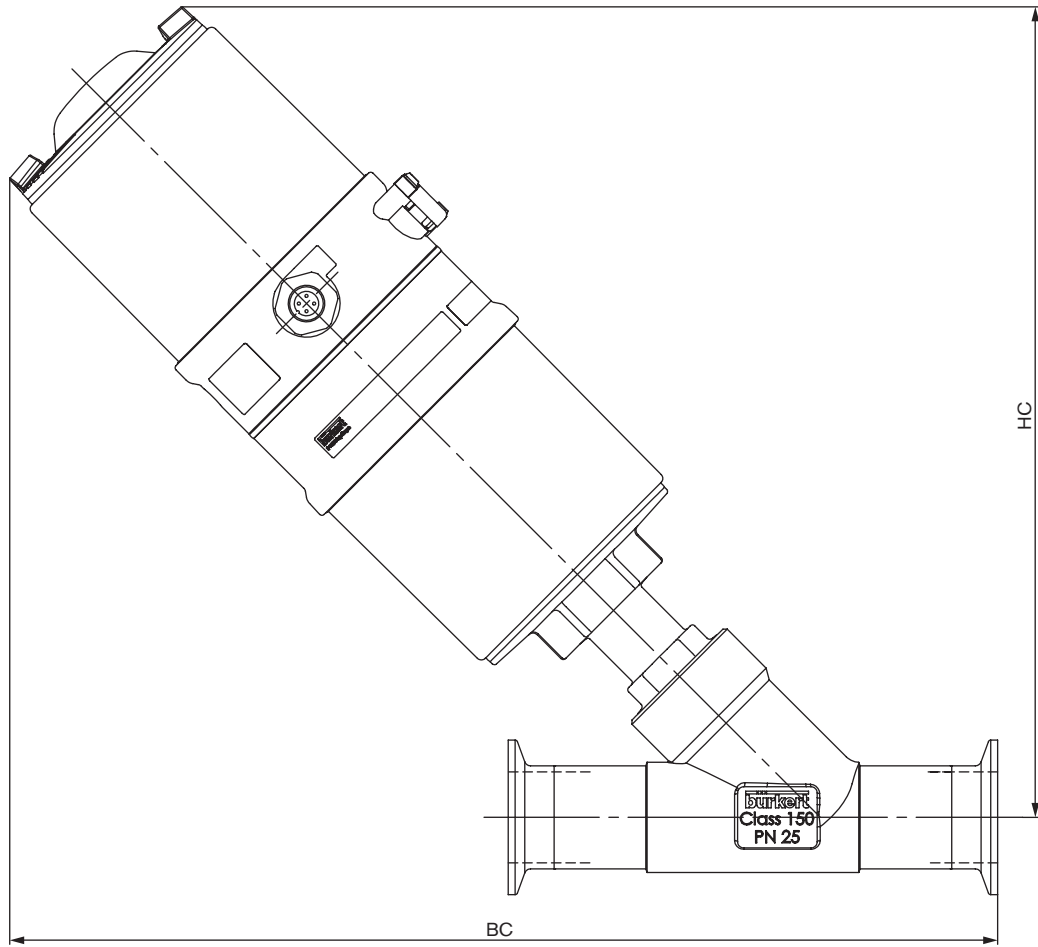

Clamp body acc. to ISO 2852, DIN 32676, BS 4825, ASME BPE

Orifice [mm]	Actuator size [mm]	HC	BC
15	70	256	309
20	70	264	324
25	70	266	327
32	70	275	336
	90	318	376
40	70	279	351
	90	321	392
	130	358	427
50	70	297	378
	90	337	416
	130	374	451

Further dimensions see p. 6

Dimensions for valve system On/Off ELEMENT Type 8801-YE [mm], *continued*

Dimensions valve system On/Off ELEMENT Type 8801-YE-M (with pneumatic control unit Type 8695)

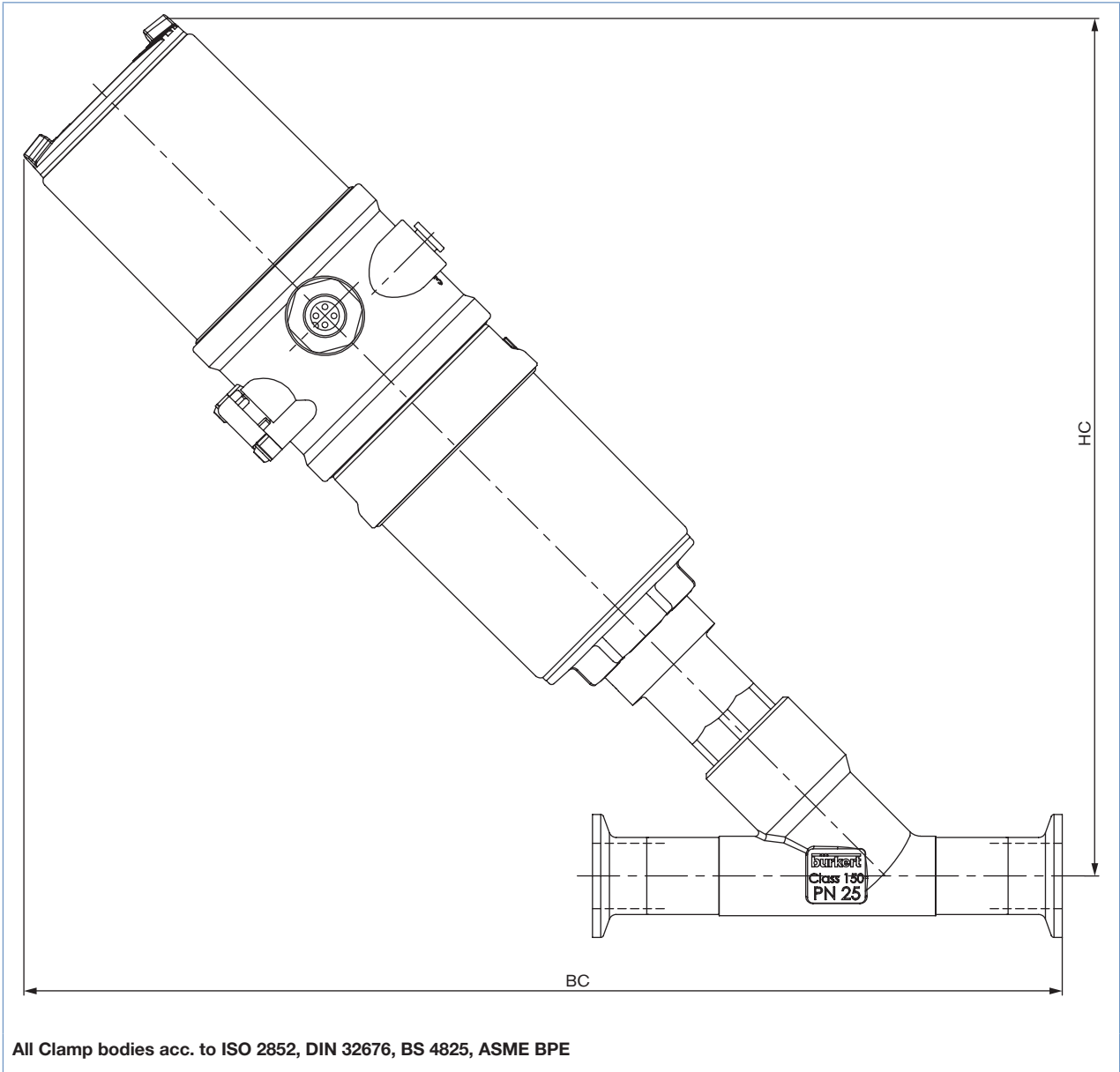

All Clamp bodies acc. to ISO 2852, DIN 32676, BS 4825, ASME BPE

Orifice [mm]	Actuator size [mm]	HC	BC
15	50	239	291
20	50	247	306
30	50	248	309

Further dimensions see p. 6

Note
You can fill out the fields directly in the PDF file before printing out the form.

Valve system On/Off ELEMENT Type 8801-YE – request for quotation

▶ Please fill out and send to your nearest Bürkert facility* with your inquiry or order

Company	Contact person
Customer no.	Department
Address	Tel./Fax
Postcode/town	E-Mail

= mandatory fields to fill out Quantity Required delivery date

Operating data

Pipe line DN PN

Pipe material

Process medium

Type of media Liquid Steam Gas

Valve features

Seal material PTFE NBR Other

Nominal pressure PN

Orifice DN

Type of connection Threaded Welded Clamp

Standard connection ISO DIN Other

Body material selection with welded connection acc. to EN ISO 1127/ISO 4200 and DIN 11850 Stainless steel 316L

Control function NC¹⁾ NO¹⁾ Double-acting

Pilot pressure min. max.

Atex II 2GD Mechanical

Please specify article no. (if known):









¹⁾ NC: normally closed by spring action; NO: normally open by spring action

Continued on next page →

Valve system On/Off ELEMENT Type 8801-YE – request for quotation, *continued*

Automation unit features

Click on the orange box "More info"... you will come to our website for the resp. product where you can download the data sheet.

Control Head		Pneumatic Control Unit / Feedback	
<input type="checkbox"/> Type 8691  For actuator size Ø 70/90/130 mm 	<input type="checkbox"/> Type 8695  For actuator size Ø 50 mm 	<input type="checkbox"/> Type 8690  For actuator size Ø 70/90/130 mm 	<input type="checkbox"/> Type 8697  For actuator size Ø 50 mm 
<ul style="list-style-type: none"> • Inductive position sensor with automatic Teach function • Coloured high power LEDs • With/without pilot valve for single or double-acting actuators • Fieldbus communication • Hygienic stainless steel design 	<ul style="list-style-type: none"> • visual status indicator • Micro- or proximity switches for end position feedback • With/ without pilot valve for single or double-acting actuators • Optional intrinsically safe version acc. to ATEX / IECEx 	<p>Pneumatic function</p> <input type="checkbox"/> Single-acting <input type="checkbox"/> Double-acting (only with 8690) <input type="checkbox"/> Without pilot valve	<p>Number of Position feedback switches</p> <input type="checkbox"/> 1x <input type="checkbox"/> 2x
<p>Pneumatic function</p> <input type="checkbox"/> Single-acting <input type="checkbox"/> Double-acting <input type="checkbox"/> Without pilot valve	<p>Electrical connection</p> <input type="checkbox"/> Cable gland <input type="checkbox"/> M12 connector	<p>Position feedback switches</p> <input type="checkbox"/> Micro-switch 24 V DC <input type="checkbox"/> Micro-switch 50 – 225 V DC/AC (only 8697) <input type="checkbox"/> Inductive switch 3-wire PNP <input type="checkbox"/> Inductive switch 2-wire NAMUR <input type="checkbox"/> Inductive switch 2-wire 24 V DC <input type="checkbox"/> without	<p>Electrical connection</p> <input type="checkbox"/> Cable gland <input type="checkbox"/> M12 connector
<p>Communication</p> <input type="checkbox"/> AS-Interface <input type="checkbox"/> DeviceNet <input type="checkbox"/> without	<p>Approvals</p> <input type="checkbox"/> ATEX cat. 3GD, IECEx <input type="checkbox"/> without	<p>Approvals</p> <input type="checkbox"/> ATEX cat. 3GD, IECEx <input type="checkbox"/> ATEX cat. 2DG, IECEx <input type="checkbox"/> without	

Certifications

- Attestation of compliance with the order EN-ISO 10204 2.1 (Article no. 440788)
- Test report EN-ISO 10204 2.2 (Article no. 803722)
- Certification of Conformity for Raw Material EN-ISO 10204 3.1 (Included in delivery)
- EN161 (European Gas Device guideline)
- FDA and USP compliance

Comment /sketch

*To find your nearest Bürkert facility, click on the orange box → www.burkert.com

In case of special application conditions,
please consult for advice.

Subject to alteration.
© Christian Bürkert GmbH & Co. KG

1801/14_EU-en_00895155